



Instruction Manual

for

L F- 8800

Temperature Controlled Soldering/Desoldering Station

For Lead-free soldering application and rework on professional SMD electronics.

INTRODUCTION

Thank you for purchasing Xytronic's high power soldering/desoldering station – the best solution for all your soldering/desoldering equipment needs especially for the lead free applications! We believe you will be more than satisfied with the many features and the versatility of your new soldering/desoldering station. **Please carefully** read the instruction manual to maximize the advantages of using your new LF-8800 soldering/desoldering station.

 **WARNING:** This appliance is not intended for use by children or other persons without assistance or supervision if their physical, sensory or mental capabilities prevent them from using it safely. Children should be supervised to ensure that they do not play with the appliance. Failure to observe the safety regulation will result in a risk to life and limb. The manufacturer shall not be liable for damage resulting from misuse of the unit or unauthorized alterations.

 **CAUTION:**

- ◆ Always place the soldering & desoldering irons in its original holder when not being used.
- ◆ Keep the soldering and desoldering tip and heating element away from the body, clothes and flammable material when in operation.
- ◆ The soldering and desoldering tip and the heating element are still remaining hot after being switched off. Ensure that you do not touch the tips and the heating elements.
- ◆ For your health, do not inhale solder fumes.
- ◆ You must not undertake work on live parts. Only the technician is permitted to undertake repairs. Use the original replacement part only.

KEY FEATURES

- **HEATER/SENSOR FAILED DETECTION:** If sensor circuit failed that the display reads "S--E" and cut off the heater power. If heater circuit failed the display will read "H--E" and cut off the heater power.
- **TEMPERATURE "LOCK-OUT" FEATURE:** The temperature can be locked by "password" code that is convenient for production line management.
- **ESD SAFE AND SPIKE FREE CIRCUITRY:** The "Zero Voltage" electronic switching design also protects voltage and current sensitive components (CMOS devices, etc.) against damaging current and transient voltage spikes commonly produced by less efficient, mechanically switched stations.
- **DELAYED SUCTION:** To eliminate the problem of solder clogging up the tip, a delayed switch feature has been incorporated for the unit that allows the pump to continue sucking for 1.5 seconds after the actuator switch is released.

- **LIGHTWEIGHT SOLDERING IRON:** Ergonomic mini handle that stays cool and prevents operator fatigue.
- **ENERGY SAVER MODE:** If the station has been idle for 20 minutes, the energy saver feature will automatically engage, the temperature goes down to 150°C from the set temperature. Activating the solder/desolder wands will disengage the power saving feature and the unit will immediately ramp up to the preset temperature. When over 40 minutes without operation the main power will be switched off to “sleep mode” which cuts power consumption and extends tip life.
Please note: You have to switch off the unit first and then switch “ON” again to commence work when the unit goes to “Sleep” mode.
- **IRON WORKING OPTION:** Both soldering, desoldering irons can be used at the same time. You can also set by pressing keys “SET + ▲” when you only use soldering or desoldering iron. At this time, the iron which you set will enter the power off suspend status. It means that the heater power is cut off. If press “▼” then the heater power will be on.
- **OPTIONAL SMD TWEEZERS :** The additional feature is specially designed for SMD chips, SOT, Flat pack ICs’ etc. reworking. TWZ90 Tweezers can be interchangeable with soldering iron as an option. Be sure before proceeding this operation, the main switch must be “OFF” to avoid any damage to the unit.

PRODUCT DESCRIPTION

LF-8800 operates with the high power 32V/100W output that is specially designed for lead-free soldering/desoldering works to meet RoHS requirement. This unit built in a self-contained, oil free, maintenance free, and quiet running vacuum pump which is electronically controlled and will not overload with continuous use, eliminating the need for additional shop air. The vacuum pump provides up to 50cm/Hg (20in/Hg) suction power, activated by a push button switching circuit located on the desoldering wand. Internal solder collector in handpiece is quickly and easily removed for cleaning. The inside mesh aluminum cooling strip has better solder chip adherence. Also the ventilation slots makes for a cooler handle, improving operator comfort.

LF-8800 incorporates electronic circuitry which enables the user to set the soldering tip temperature from 150°C (302°F) through 480°C (896°F) and desoldering tip temperature from 300°C (572°F) through 450°C (842°F) without changing tips or heating elements. Also, with digital display readout and pressing keys on the front panel get clear vision and comfortable setting. The temperature is maintained within $\pm 3^{\circ}\text{C}$ ($\pm 6^{\circ}\text{F}$) of its operating temperature by a thermocouple sensor to ensure maximum temperature as close to the working surface of the tip as possible. This results in both a rapid heat up, fast recovery and exacting temperature control with minimal overshoot.

The revolutionary "Zero Voltage" electronic switching design also protects voltage and current sensitive components (CMOS devices etc.) against damaging current and transient voltage spikes commonly produced by less efficient, mechanically switched stations. The power unit is isolated from the A.C. line by a transformer and allows 32Vac for soldering and desoldering to drive the heating elements.

The new LF-8800 has been developed to meet the present and future needs of the electronic production industry and is ideal for use at any AC outlet. Engineered to meet the demanding needs of the hobbyist, service & repair technician as well as production people alike.

BRIEF INTRODUCTION OF PANEL FUNCTIONS:

Front panel

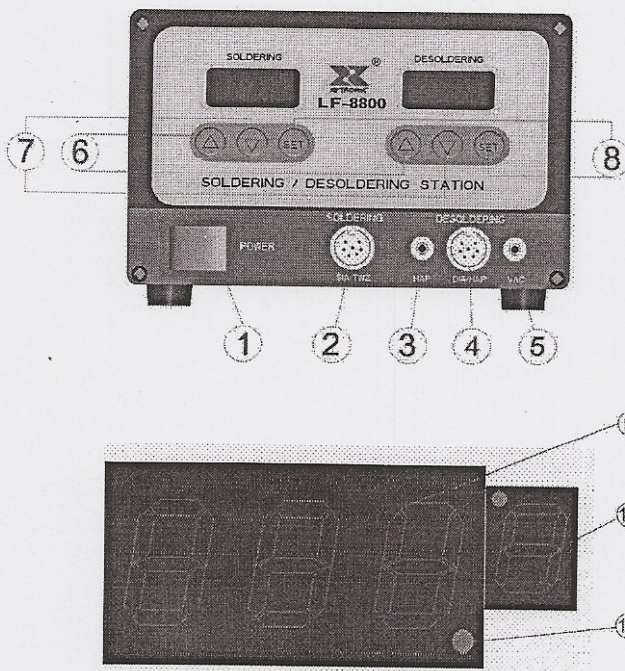

- ① Main power switch
- ② SIA: Solder/Tweezer wand socket
- ③ HAP: Hot air fitting
- ④ DIA: Desolder/HAP wand socket
- ⑤ VAC: Desoldering vacuum tube fitting
- ⑥ "▲" - "Up" key
- ⑦ "▼" - "Down" key
- ⑧ "SET" - Function key

- ⑨ Temperature display readout
- ⑩ Degrees Celsius or Fahrenheit display
- ⑪ Heat indicating light

SPECIFICATIONS:

Model		LF-8800	
Input		100-120Vac 60Hz	220-240Vac 50 Hz
Fuse		T3.15A	T2A
Output	Soldering	32Vac/100W	
	Desoldering	32Vac/100W	
Temperature Range	Soldering	150-480°C	
	Desoldering	300°C-450°C	
Temperature Correction Range		+99°C~-99°C	
Default Set	Soldering Temperature	150°C	
	Desoldering Temperature	300°C	
Dimensions		105 x 90 x 126mm (W x H x D)	
Weight (Unit only)		6.5kg	

FUNCTION INTRODUCTION

TEMPERATURE SETTING: (No password set)

1. Increase temperature: By pressing “▲” key one time, the digital will be increase “1” numeral. If pressing “▲” key over 2 seconds then the digital numerals will be forwarded counting continuously till the temperature up to what you desire to set.
2. Decrease temperature: By pressing “▼” key, the same procedure as above.

PARAMETER SETTING:

1. Press “SET” key and hold for at least 5 seconds until display shows“— — —” sign then release the “SET” key. The sign “— — —” starts to flash and reminding the user to input the mode lock password “010” (fixed). If the user inputs the same number as “010”, the unit will enter the modes selection procedure, otherwise, the unit will be back from the current mode automatically.
2. After the unit enters the Modes selection, the LED will display “F-0”and flash. Press “▲”or “▼” key to select modes. If the user doesn’t press “▲” or “▼” key within 15 seconds or press “SET” key one time, then the unit will be immediately back from the Parameter Set status.

For example: F-0 → F-1 → F-2 → F-3 → F-4

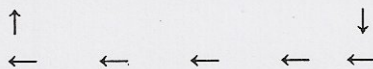

3. Password Setting:

When the LED displays “F-1” and flashes, press “SET” key one time and the unit enters the Password Set status. At this moment, the LED displays the pre-set value.

Press “▲” or “▼” key to change password set value. If the user sets “000” that means the unit will be under the status of no password. If the user sets “100” then means the unit will be under the password status. Press “SET” key once to finish password setting and the unit will backup mode, the user can continue set other modes or back from the setting mode.

4. Temperature Correction Setting

Press “SET” key once when the LED displays “F-2” and flashes that the unit enters the Temperature Correction Mode. At this moment, the LED displays preset correction value.

A: Operation of Centigrade temperature correction ($+99^{\circ}\text{C}\sim-99^{\circ}\text{C}$)

Press “▲” or “▼” key to change the temperature correction value. The first digit “—” means minus (actual temperature is down), “No display” means plus (actual temperature is up).

B: Operation of Fahrenheit temperature correction value ($+210^{\circ}\text{F}\sim-210^{\circ}\text{F}$)

Press “▲” or “▼” key to change the temperature correction value. When the numbers is sparkling on LED displays, it means minus value (actual temperature is down), when the numbers stop sparkling, it means plus value (actual temperature is up). Press “SET” key once to finish the temperature correction and the unit automatically backup mode.

The user may continue set other modes or back from the current setting mode.

Example for temperature correction: The current set temperature value is 300°C , however, the actual temperature is only 290°C . So it needs to correct by $+10^{\circ}\text{C}$. Correction method: if the current correction value is 00 or -00; then change it to 10. If the current correction value is -20, then change it to -10. If the current correction value is 20, then change it to 30.

5. Sleep Mode Set

Press “SET” key one time when the LED displays “F-3” and flashes, the unit enters the Sleep mode status. At this moment, the LED displays the pre-set value. Press “▲” or “▼” key to change the set value. If set value reads “000” that means the unit set in “Sleep” mode releasing status. If the display read “100” that means the unit set in “Sleep” mode. Press “SET” key once to finish the sleep mode setting, then the unit automatically backup. The user may continue set other modes or back from current set mode.

*Please note the manufacturer original design will keep in “Free” status without setting “Sleep” mode.

6. Wake-up method

- *Temperature Down Suspend: If the unit is set at Sleep mode function, after 20min idleness, the system will enter the sleep mode automatically, the temperature of soldering will go down to 150°C (302°F) / and the LED displays at “150” and flashes, the temperature of desoldering will go down to 200°C (392°F) and the LED displays at*

“ 200” and flashes. Activating the solder wand will disengage the suspend status and the unit will immediately ramp up to the preset temperature.

There are three methods to wake-up the Temperature Down Suspend.

a. I Soldering : Pick up the solder wand and shake it gently.

II Desoldering: Pick up the solder wand and press the red suction button on the DIA 100.

b. Press any key of the unit.

c. Turn off the main switch and restart.

② Power off Suspend: If the unit enters the Sleep mode over 40min without wake-up, the unit will enter automatically the power off suspend status. It means the heater power will be cut off and the LED displays “— — —” and flashes. You can wake it up by pressing “▼” key when you reuse the iron or turn off the main switch and re-switch on.

7. Fahrenheit and Centigrade (Celsius) temperature selection

When temperature display window shows "F-4" and blinking, press the "SET" button, at this time ,the system enters the degrees Fahrenheit and Centigrade temperature selection function, indicating the temperature of the window shows the current status. Press "▲" or "▼" key to change the temperature selection status. It expressed as degrees Celsius temperature value if set to “C” ; it shows as degrees Fahrenheit temperature if set to °F

WORKING TEMPERATURE

SOLDERING

To meet RoHS requirements, the common 60/40 lead solder alloys are not allowed in the production process. Lead free solder alloys require a working temperature of 30°C (54°F) higher than previous generation electrical soldering. The working temperature of solder is detailed below and can vary from manufacture to manufacture.

Melting point	220°C (428°F)
Normal operation	300-360°C (572-680°F)
Production line operation	360-410°C (680-770°F)

When the soldering iron’s working temperature is set within the parameters suitable for the type of soldering being used, a good joint assured. Too low of a temperature will slow the rate of solder flow while a high temperature setting might burn the flux in the solder and emit a heavy, white smoke resulting in a dry joint or permanent damage to the printed circuit board (P.C.B) and may also shorten tip life.

IMPORTANT· The temperature above 410°C (770°F) is not recommended for normal soldering functions, but can be used for short periods of time when high temperatures are required.

DESOLDERING

Recommended tip working temperatures are detailed below and can vary from joint to joint.

Operation for small joint	320°C - 360°C	(608°F - 680°F)
Operation for larger joint	370°C - 400°C	(698°F - 752°F)

Too low of a temperature will slow the flow rate of solder and may clog the tip. Too a high temperature ay burn the P.C.B.

OPERATING INSTRUCTIONS

1. Ensure that the working voltage matches your power supply before beginning use.
2. Check carefully for any damage during transportation.
3. This unit contains:
 - A: DIA100: Desoldering iron assembly with tip.
 - B: 307A: Soldering iron assembly with tip.
 - C: Two iron holders with tip cleaners for both soldering and desoldering.
 - D: AC Power cord with plug.Accessories included:
 - a. One cleaning brush
 - b. One cooling strip
 - c. One 0.7 ϕ probe
 - d. 4pcs of filters
4. Optional parts:
 - A) TWZ90: 32V/100W Tweezers can be interchangeable with soldering iron.
 - B) HAP80: 32V/80W Hot air blow pencil can be interchangeable with DIA100.

OPERATING PROCEDURES

1. Ensure that the base unit's power switch is in the 'OFF' position.
2. Plug in "Solder and Desolder" wands, connect "Vacuum tube" to "VAC".
3. Connect AC power cord to mains "In-Let".
4. Switch "Mains power switch" to "ON" position.
5. Press the " \blacktriangle " key up until the temperature to 250°C (482°F) (If set to degrees Centigrade, the temperature display window of the upper right corner shows °C, if set to degrees Fahrenheit, the temperature display window of the upper right corner shows °F).
6. Then tin the surface of both soldering and desoldering tips by applying a new covering of solder to protect it.
7. You can set the desired temperature setting by pushing the "up" or "down" key. When the temperature reaches to the desired temperature that the heating indicator light will be flashed on and off to maintain the set temperature. The unit now is ready for use.
8. When you only use soldering iron or desoldering iron, you can set the power off suspend mode by pressing keys "SET + \blacktriangle ". At this time, the iron which you set will enter the

power off suspend status. The display shows “— — —”. It means that the heater power is cut off. You can wake it up by pressing “▼” key when you reuse the iron.

★ Please note both DIA & SIA can be operated at the same time.

CAUTION: Do not touch any of the irons at any time while the unit is on or while it's cooling as they will still be hot.

IMPORTANT

DESOLDERING

1. Only activate the vacuum after the solder has completely melted. Melting is accomplished by moving the hot tip around the lead leaving visible melted solder on the component side of the P. C. B.

See Fig. 1 & 2.

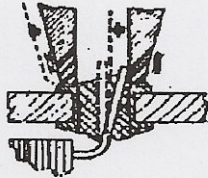

FIG-1

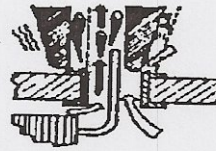

FIG-2

2. Release the vacuum switch only after the solder on the tip has been removed, otherwise the tip may clog.
3. Add solder to the joint of the component and allow the solder to melt completely for improved desoldering.
4. Remove the solder collector and clean it after no more than 200 applications. However, daily cleaning is strongly recommended.
5. Replace the cotton pad in the solder collector and the in-line filter when they begin to turn yellow.
6. If there is insufficient vacuum, use the spring wire included to clean the tip and also check the in-line filters.
7. Be sure that all filters are in place during operation or damage to the vacuum pump may occur.
8. Follow the steps outlined in the OPERATING PROCEDURE section of this manual if a new tip is to be installed.

COMMON CAUSES FOR TIP UNWETTING

1. Tip temperatures higher than 410°C (770°F).
2. The tip working surfaces are not tinned while the iron idling.
3. Lack of flux in soldering, wicking, repair, and touch-up operations.
4. Wiping the tip on a high sulfur content, dirty or dry sponge.
5. Contact with organic substances such as plastic, resin, silicone, grease and other chemicals.

6. Impurities in the solder and/or low tin content.

CARE OF TIPS

CAUTION: The soldering, desoldering irons can reach very high temperature. Be sure to turn the unit off prior to carrying out any maintenance or trouble shooting steps listed below!

IMPORTANT:

Remove the tip and clean after each moderate to heavy use or daily for light usage. Remove any loose build up in the tip retaining assembly to prevent tip freezing.

Both solder, desolder tips supplied are iron clad copper and if used properly should maintain optimum life.

1. Always tin the tip before returning it to the holder, turning off the station, or storing it for long periods of time. Wipe the tip on a brass cleaner prior to use.
2. Keeping the iron set at high temperatures (more than 400°C or 750°F) will shorten tip life.
3. Do not use excessive pressure on the tip or rub the joint with the tip while soldering and/or desoldering; it does not improve the heat transfer and may damage the tip.
4. Apply solder to the joint, not the tip when soldering. The flux is naturally caustic and thus will eat away the tip.
5. Never clean the tip with a file or abrasive materials.
6. Do not use fluxes which contain chloride or acid. Use only rosin or rosin activated fluxes.
7. If an oxide film forms, it can be removed by careful buffing with 600-800 grit emery cloth, isopropyl alcohol or equivalent and then the tinned areas with rosin-core solder after the resin-core has melted.

NEW TIPS

Applying the following steps give the tip optimum life.

1. Set both temperature to min. then turn the main power switch to the "ON" position.
2. Set soldering tip temperature to 250°C (500°F approx.) and desoldering tip temperature to min. Coat the tinned surfaces with rosin-core solder after reaching 250°C.
3. Set to the desired temperature about 3 minutes after being warmed that the station will be ready for use once it reaches preset temperature.

IMPORTANT: Remove and clean the tip daily. If a new tip is installed, remove any loose build up in the barrel assembly, otherwise the tip may fuse to the heating element or retaining barrel.

METHOD TO CHECK FOR LOSS OF SUCTION

The following procedures should be used on LF-8800 to check whether loss of suction is due to the tip, solder collector, tube or in-line filter.

CAUTION: THE DESOLDER SWITCH MUST BE "OFF" AND ALLOW THE IRON TO

COLL BEFORE ATTEMPTING THE FOLLOWING PROCEDURES:

1. Disconnect vacuum tube from the fitting on the front panel, place finger over the hole of the fitting, depress vacuum switch and you should have a strong vacuum. If not, send back to your nearest service center for pump repair.
2. Disconnect the inline filter from the iron assembly, depress vacuum switch, replace filling of the in-line filter if there is little vacuum pressure or the filters are discolored.
3. Remove solder collector from desolder iron assembly, place finger over the hole of the collector, depress vacuum switch. There is little suction clean or replace the collector tube.
4. Depress vacuum switch, clean the tip tube with spring wire provided if there is no suction per the "Procedure for Cleaning Clogged Tip" section below.

MAINTENANCE

DESOLDER TIP REPLACEMENT AND DRESSING

Desolder tips can be changed or replaced simply unscrewing the barrel nut assembly. The station must be turned off and allowed to cool before this operation. If the system is left on without a tip in place, damage to the iron assembly may occur!

After removing the tip, blow out any oxide dust that may have formed in the tip receptacle. Be careful not to get dust in your eyes. Replace the tip according to Figures 3-9 and hand tighten the securing screw for the barrel nut assembly. Pliers can be used to avoid contact with hot surfaces **BUT SHOULD BE USED WITH CAUTION** because over tightening may cause damage to the element or fuse the tip to the element.

PROCEDURE FOR CLEANING CLOGGED TIPS

CAUTION: This procedure is to be working in high temperature. Be careful to avoid burning your fingers during this operation.

1. Be sure that the spring wire (included) will not go through the nozzle of the desolder tip.
8. Adjust the heating element to a higher temperature allowing the clogged solder to melt. Clean the tip by sliding the spring wire up and down until the passage is clear. (See Fig. 3)

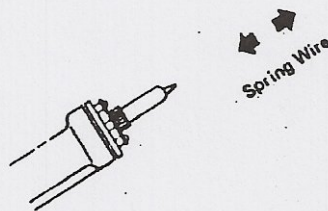

9. Unscrew the barrel nut assembly as in Figures 4 & 5.

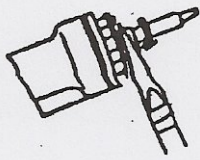

FIG-4

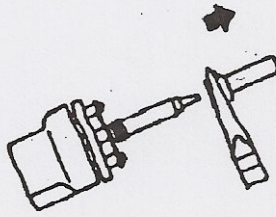

FIG-5

10. Remove the tip by using a pliers as in Figures 6 & 7.

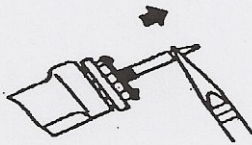

FIG-6

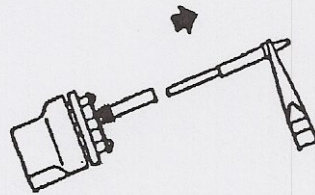

FIG-7

11. Insert the stainless tube of the tip back in the barrel to melt the solder in around 5 seconds as in Figure 8.

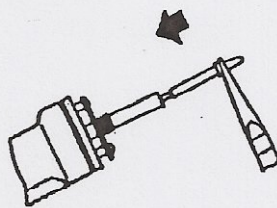

FIG-8

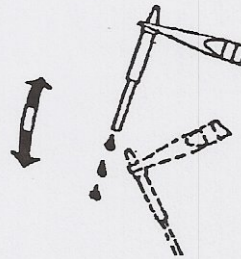

FIG-9

12. Remove again and shake out any loose melted solder in the tip per Figure 9, the tip should now be unclogged. Replace the tip and screw back the retaining barrel nut assembly but care should be taken not to over tighten!

PROCEDURES FOR CLEANING THE SOLDER COLLECTOR

CAUTION: The desolder switch must be turned "OFF" and the iron allowed to cool before this operation.

1. Hold iron as in Figure 10. Press and turn the red knob at the butt of the iron.

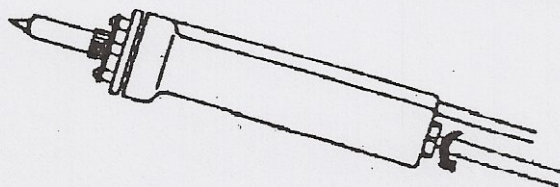

FIG-10

2. Slide out the solder collector as in Figure 11. (CAUTION: The solder collector is glass and thus retains heat, handle with care!)

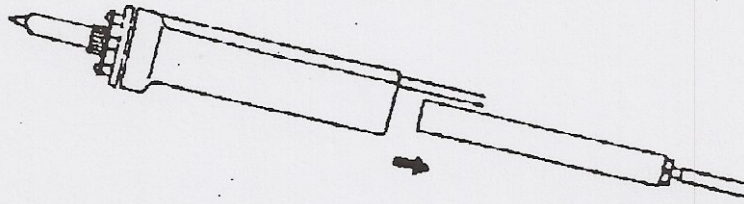

FIG-11

3. Point the collector down while shaking slightly (see Figure 12.) and the waste solder will fall out. This task must be carried out periodically for proper operation of the station.

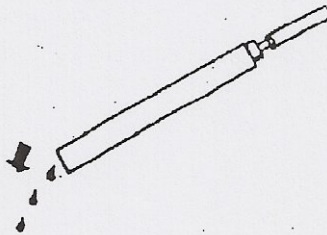

FIG-12

4. Remove cooling strip with a pair of long nose pliers or tweezers. (see Figures 13 & 14)

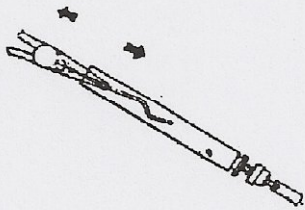

FIG-13

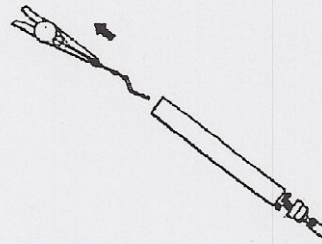

FIG-14

5. Clean the cooling strip and glass collector with wire brush (included).

PROCEDURE FOR REPLACING FILTERS

SOLDER COLLECTOR FILTERS

1. Be sure the iron/filter assembly have cooled.
2. Hold iron as in Figure 10, press/turn red knob on the butt of iron.
3. Remove solder collector (see Figure 11).
4. Disassemble the solder collector into 2 pars (see Figures 15 & 16).

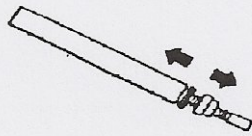

FIG-15

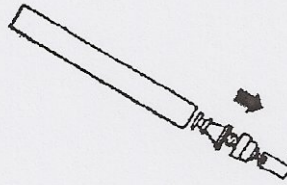

FIG-16

5. Remove old cotton filter and replace.(see Figures 17 & 18).

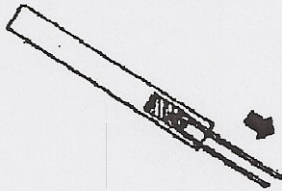

FIG-17

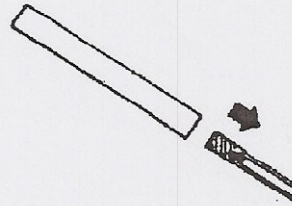

FIG-18

IN LINE FILTERS

1. Unscrew in line filter (see Figure 19) and then pull apart (Figure 20).



FIG-19

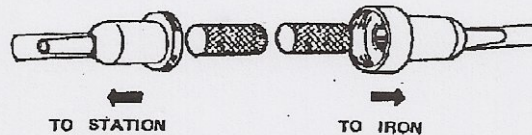
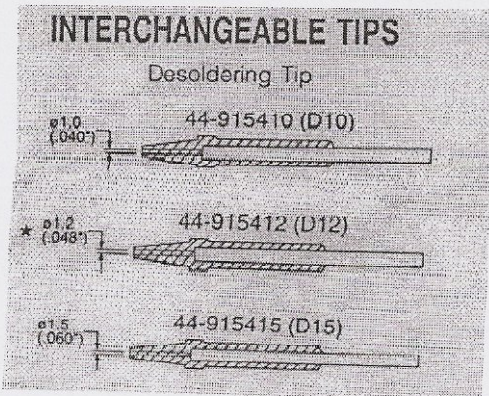

FIG-20

INTERCHANGEABLE TIPS FOR LF-8800

Desoldering tips for DIA60 & DIA100



Soldering tips for 307A

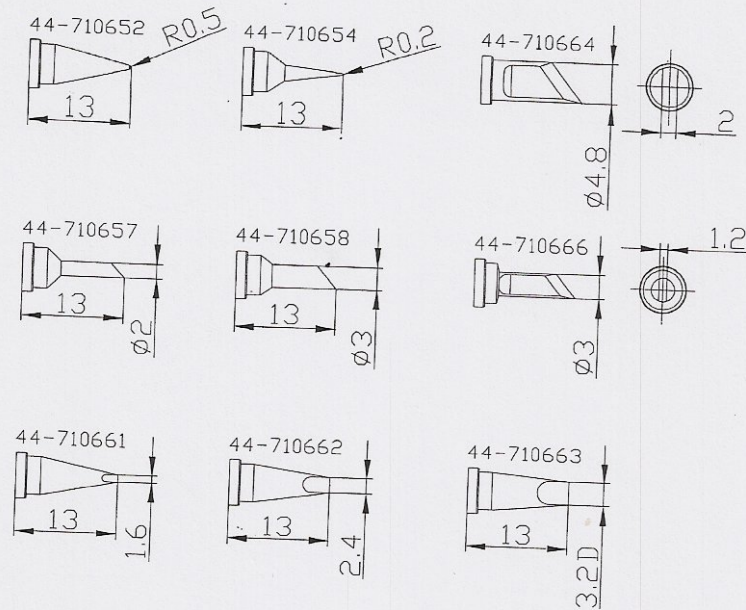

MAINTENANCE NOTE FOR DIA

Change of Cotton Filament (76-1411030):

Please note that the cotton filament cannot be washed with the water. Water drops would be sucked into the Pump and may cause the pump damaged within 1 to 2 months. If you wash with the water, **Cotton filament** will turn solid and will stop the DIA80A working well. Please change **at least once 3 to 5 days** if you use **8 hours** per day.

Change of Charcoal Filter (78-151500):

Charcoal filter will turn solid if you wash with the water. If you use 8 hours per day that the Charcoal filter has to be changed within 3 weeks. On the other hand, if you wash the Charcoal filter and do not dry properly, water drops will be sucked into the Pump and may cause the pump damaged easily.

Change of Glass Solder Collector (75-160110):

Glass solder collector will be broken easily if the client knocked the DIA80A against the desktop. The glass collector also needs to be changed every 3 to 5 months usage.

Maintenance for Desoldering Heater and Tip:

To prevent the desoldering tip being stuck by solder, the desoldering tip has to be cleaned by a Probe after every time usage. In such ways, desoldering tip's life can be lasting longer. Desolder Heater would be probably broken when you remove the desoldering tip with a pliers careless in hot condition. Slightly remove the tip with pliers or may use the anti-rusty cleaner when the tip clogged with the heater and do not forced open. Please read the "**Procedure for Cleaning Clogged Tips**" carefully on page9 on the manual.